

未注线性尺寸公差 Linear dimension tolerances

0~6	6~10	>10~30	>30~60	>60~100	>100~160	>160
±0.2	±0.3	±0.5	±0.7	±1.0	±1.3	±1.6

REV	DESCRIPTION	DRW.	DATE
A	RELEASE		

技术参数 Technical Data

螺母扭矩	Screw torque(Max)	[lbf.in]	M6 / 22
螺母扭矩	Screw torque(Max)	[lbf.in]	M10 / 80
工作温度	Operating temperature	[°C]	-40 ~ +105
环保要求	RoHS Compliant		YES

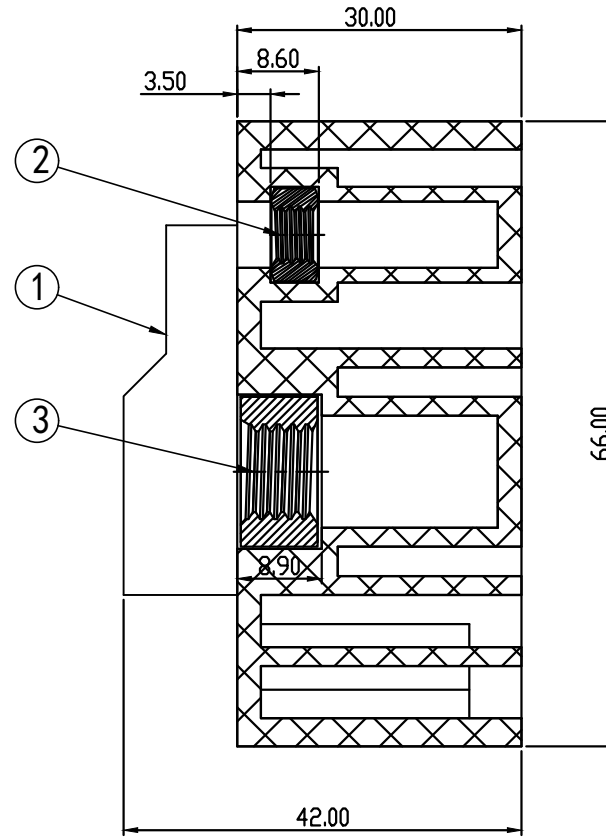
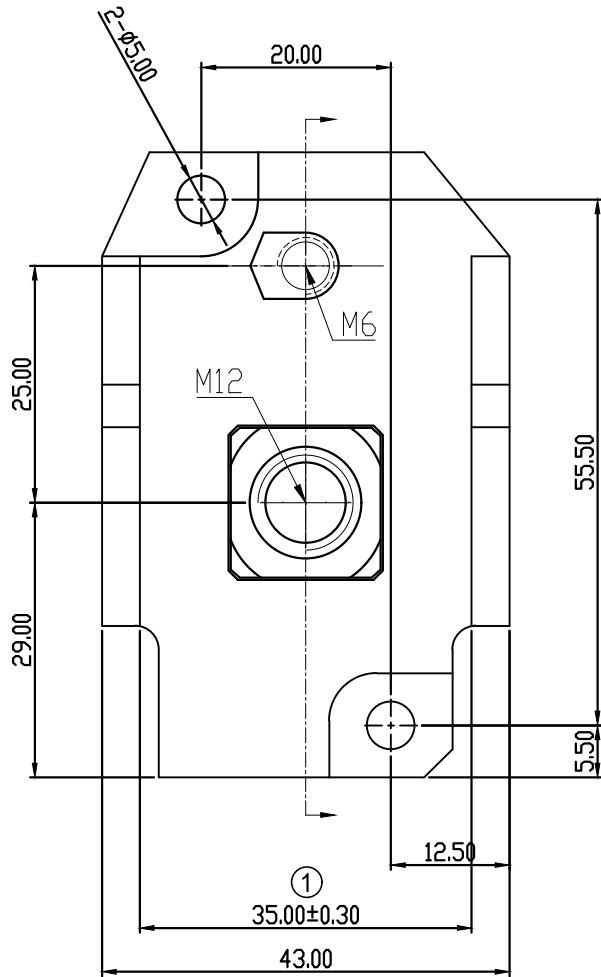

3	Nut_2	STEEL	Zn Plated
2	Nut_1	STEEL	Zn Plated
1	Housing	PA6+GF	UL94-V0
ITEM	NAME	MATERIAL	NOTES

TYPE CUSTOMER DRAWING 客户图档		PROJECTION				赋安连电气 FORANY ELECTRIC	
DRFT	刘秀海	DATE	2026.06.20	UNITS:	MM	TITLE SET350-B	
CHKD	曾裕辉	DATE	2026.06.20	SCALE:	1:1	DWG NO.	
APPD	陈柏林	DATE	2026.06.20	SHEET	1 OF 1		